



PuduBot 2

Universal Delivery Robot

— Relay of classic —



Content.

PuduBot 2

01

Product Overview

02

Key Features

03

Product Values

04

About Pudu



Product Overview

PuduBot 2

PuduBot 2, the newly upgraded delivery robot from Pudu Robotics, inherits excellent features and functions from PuduBot.

PuduBot 2 is committed to realizing intelligent deliveries in all scenarios, promoting the application of service robots and accelerating the overall robot development with higher performance, better functional extendability, environmental adaptability and reliability in use.





Product Overview

7-inch Interactive Screen

Aluminum Machine Body

Adjustable Trays

Upper Lidar

Wide FOV RGBD

Lower Lidar

Visual Camera

USB Interface

Industry-leading Chassis System

20Ah LFP Battery

Automatic Charging





Product Overview

Dimension	580mm*535mm*1290mm
Machine Weight	37kg
Tray Size	500mm*432mm
Single Tray Load	Maximum 13kg
Maximum Loads	40kg
Battery Life	10~24h
Charging Time	3h
Path Clearance	80cm
Cruise Speed	0.5m/s~1.2m/s
Obstacle Negotiation Height	10mm
Climbing Angle	$\leq 5^\circ$
Positioning Method	VSLAM & Laser SLAM
Dispatching	Maximum 20
Charging	Wire or Automatic



Content.

PuduBot 2

01

Product Overview

02

Key Features

03

Product Values

04

About Pudu



Key Features

Industry-leading Chassis System Better Stability, Better Performance

- Highly integrated chassis with newly upgraded vertical linkage suspension system
- Significantly improved obstacle-crossing capability
- Adapt to different road surfaces, **30%** improvement in moving stability
- Smooth mobility even with bumpy roads

*Source: PUDU Lab

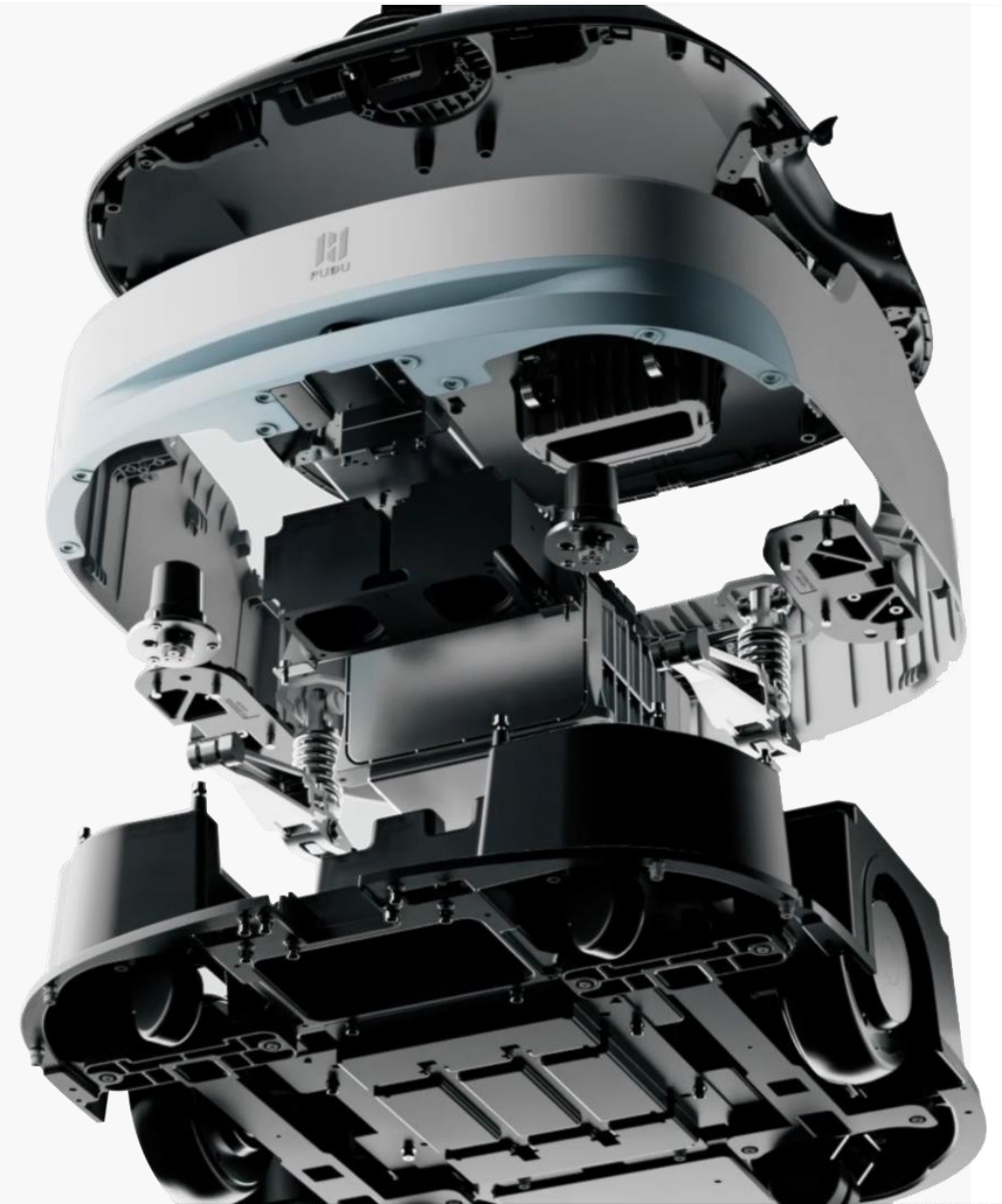



Key Features

PUDU-developed Servo In-wheel Motor
Cost Reducing, Efficiency Boosting

- 33% increasement in load capacity
- 16% improvement in energy utilization
- Excel in both performance and energy saving

*Source: PUDU Lab

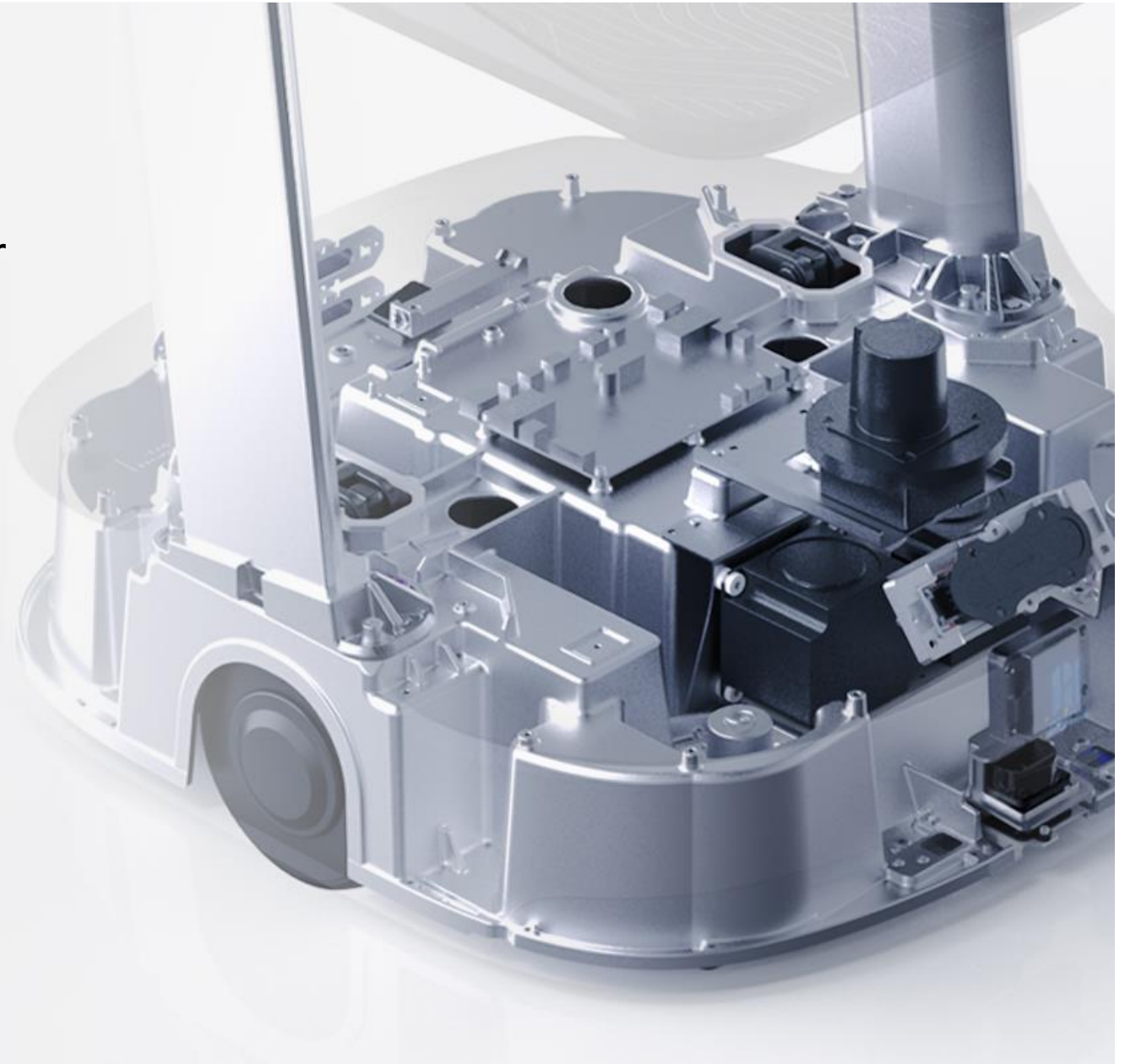



Key Features

Dual Lidar, Precise Perception More Reliable, More Secure

- Dual-Lidar system provides PuduBot 2 the ability of 360 degree sensing, with environmental features in full view
- The upper lidar is responsible for distance detection, with an effective obstacle avoidance capability within 0.8m (at a load of 40kg and 1.2m/s travel speed)
- The lower lidar is responsible for ground detection with the shortest detectable height of **8cm**





Key Features

PUDU SLAM

Simplified Deployment , Greater Adaptability

- Fusing laser and visual positioning & navigation technology
- Support Lidar SLAM, Vision SLAM, or Fusion (Lidar + Vision)
- Marker-less deployment, reducing 75% deployment time without redecoration of ceiling
- Comfortable operation even in high ceiling environment (up to 20 meters)





Key Features

High Performance LFP Battery



- Extended battery durance
- Operates up to 24h on a 3 hour charge
- 6X longer battery lifetime
- Enhanced safety and reliability

Automatic Charging



- Compatible with Pudu Charging Pile
- Automatic recharge at set time or when battery level is lower than set threshold



Key Features

Multi-Modal Delivery

- One robot serves for multiple purposes

Multi-Table Delivery

- Serve several tables at one go



Food Delivery Mode



Delivery Mode



Cruise Mode



Direct Mode



Dish Return Mode



Birthday Mode

Meet the diversified delivery needs

Key Features

Calling and Notification

Autonomous and flexible, anytime and anywhere

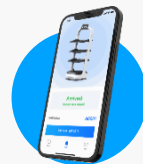

Calling Robot

- Support Pudu Watch & APP Calling
- Assign and manage tasks simply with one click



VIP Room Notification

- Notify the guests on robot arrival
- Enable more efficient delivery service for private rooms



Key Features

Fully Enclosed Machine Design



Machine Slit
 $\leq 1\text{mm}$



Effectively resist
dust and water





Key Features

Multi-Robot Collaboration

- Powerful self-organized network
- Dispatch up to 20 robots in one environment
- Realtime environmental perception
- Automatically detour for traffic congestion
- Adapt to complex and dynamic scenarios
- Allow painless collaboration among robots





Key Features

Various Forms, Versatile Accessories



Designed to meet the needs of business



Key Features

Customization Services

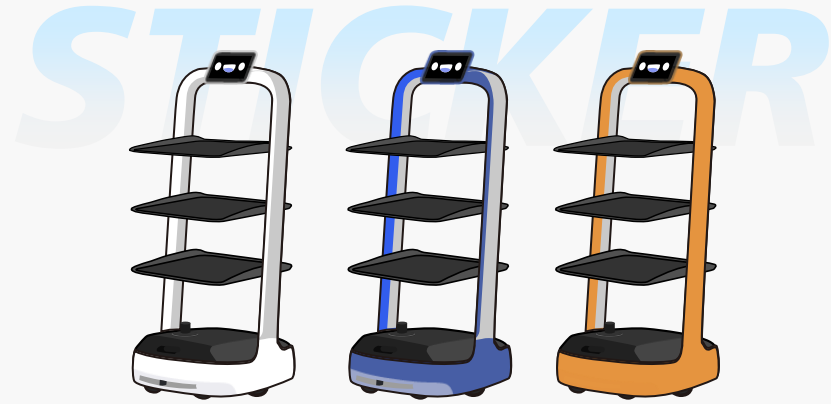

Customized Sticker

- Create your exclusive PuduBot 2 for greater brand exposure
- Make your robot unique and eye-catching



Customized Voice Pack

- Online upgrade and real-time sync.

Content.

PuduBot 2

01

Product Overview

02

Key Features

03

Product Values

04

About Pudu



Product Values

Multi-Industry, Multi-Scenario Coverage



Restaurant & Café



Hospital & Clinic



Hotel & Resort



Office



Senior Living



Manufacture



Entertainment & Leisure

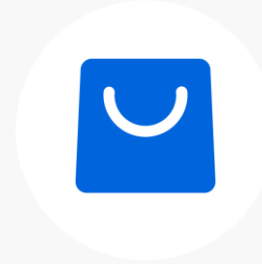

Retail



Product Values

Contact-free Delivery

The COVID-19 profoundly changes our way of life and production and lots of restaurants have offered contact-free delivery to guarantee the safe transfer of food nowadays. PuduBot 2 supports pager function and receives remote operation commands. In different use scenarios PuduBot 2 can receive demands from the pagers and collects the dishes or items automatically, reducing contagion risk between people while boosting delivery efficiency.

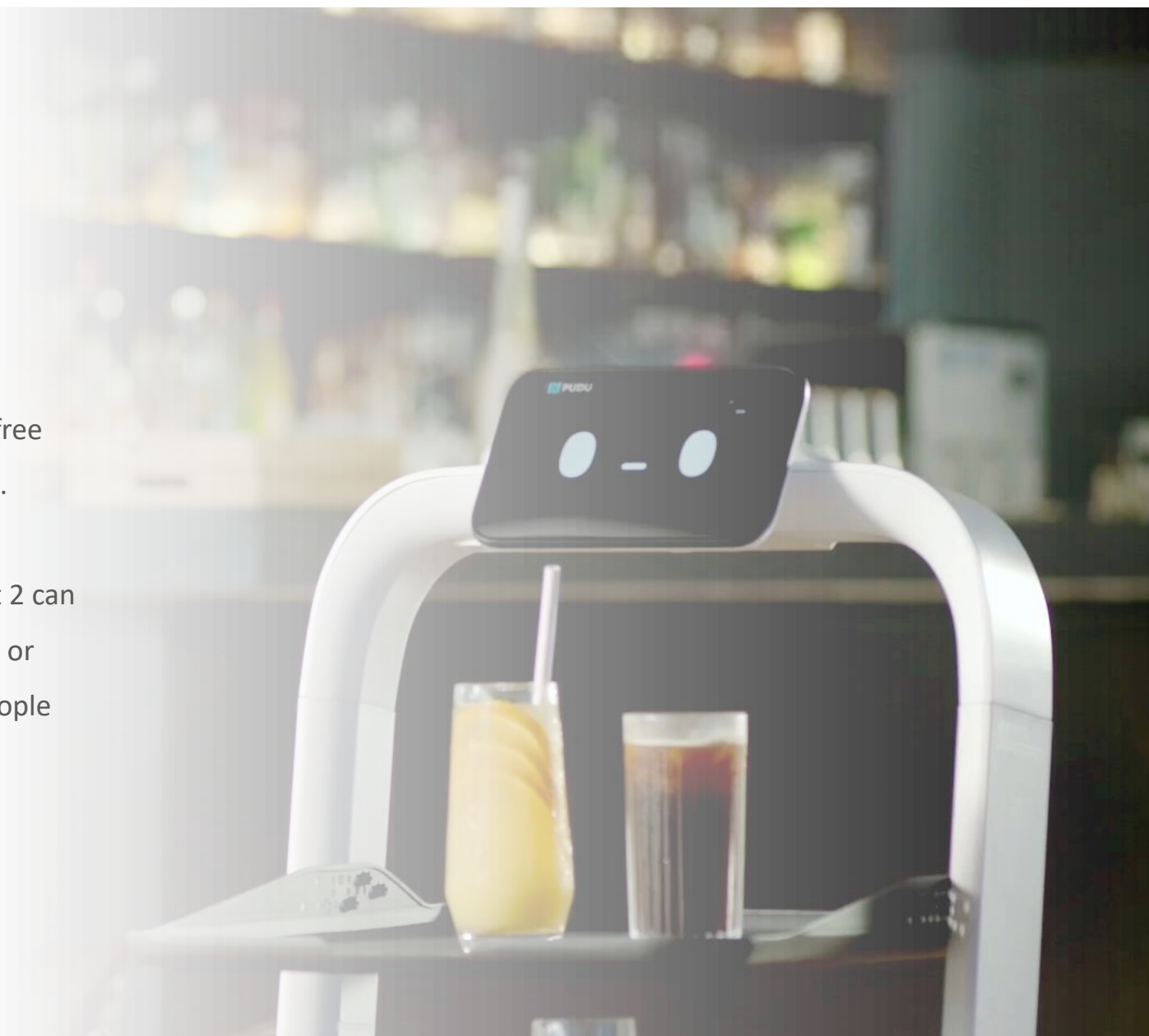

Product Values

Keep up with Trend of Restaurant Automation

Restaurant Automation is the use of automated or robotic technology to complete tasks throughout the restaurant and facility in order to simplify ordering, meals preparing, food delivery and bill payment.

Embedded in strong foundations and in-depth understanding of catering industry, PuduBot 2 possesses the significant features to streamline the food delivery services. And the powerful multi-robot dispatch system distinctly cuts down on the human labor required to stay up and table running.

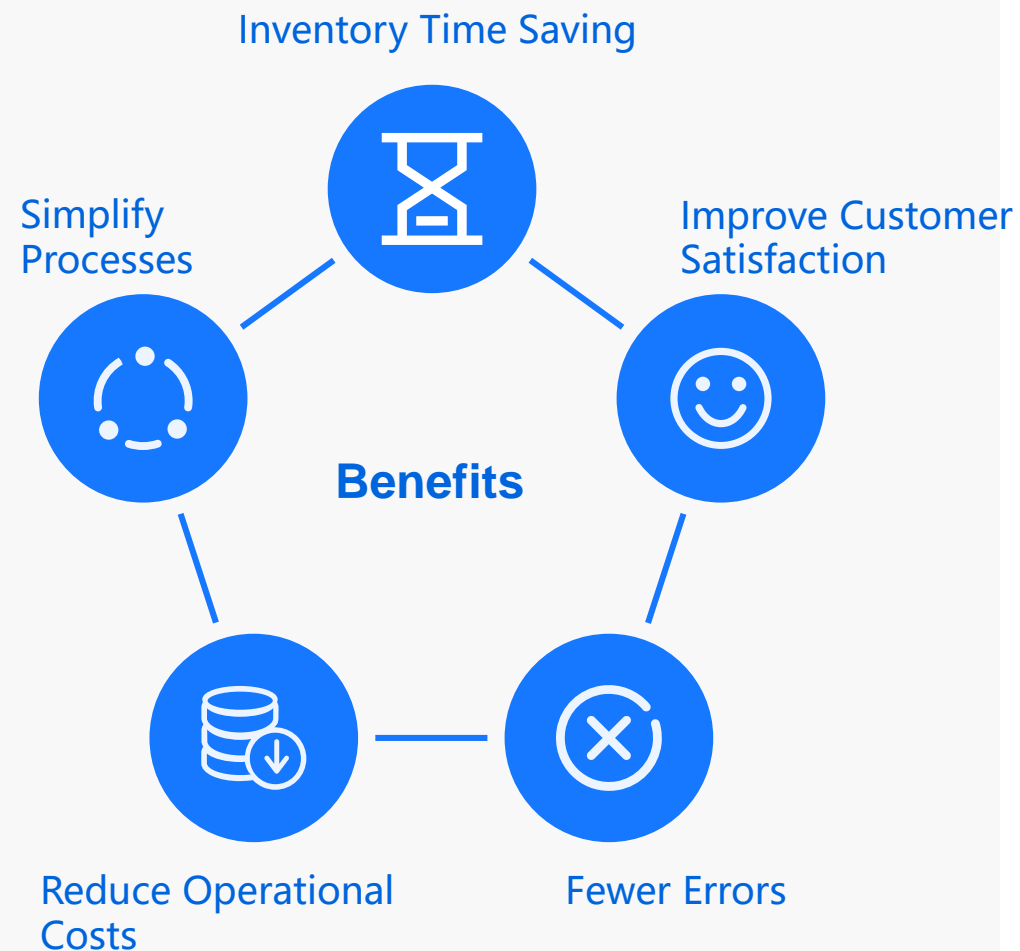

Product Values

Mitigate Labor Shortage

The pandemic has been hugely devastating to the labor market and fundamentally altered the industries and locations where would-be employees want to work. Employers are struggling in looking for and retaining qualified staffs.

Deploying robots to replace the 4-D jobs (Dull, Duplicate, Dirty and Dangerous) is trendy and will become ubiquitous in future. With the help of robots, employees may focus more on the high-value work and have a better work environment, which results in better work experience and satisfaction.

Product Values

Revolutionize Customer Experience

Commercial robots are being successfully integrated into different hospitality organizations or retail stores to improve customer experience.

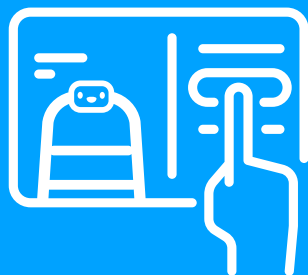

Streamlining underlying processes

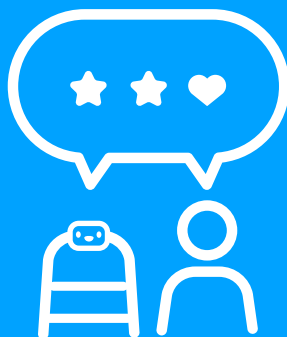

Reducing friction to create the sense of seamless and delight



Boosting customer experience by re-allocating more humans into front-facing roles



Enhancing customer journey by providing innovative experience



Your Reliable Business Partner

Build the future together

Solid partnerships starts with a shared commitment to providing superior value to you, we will support you as followed:

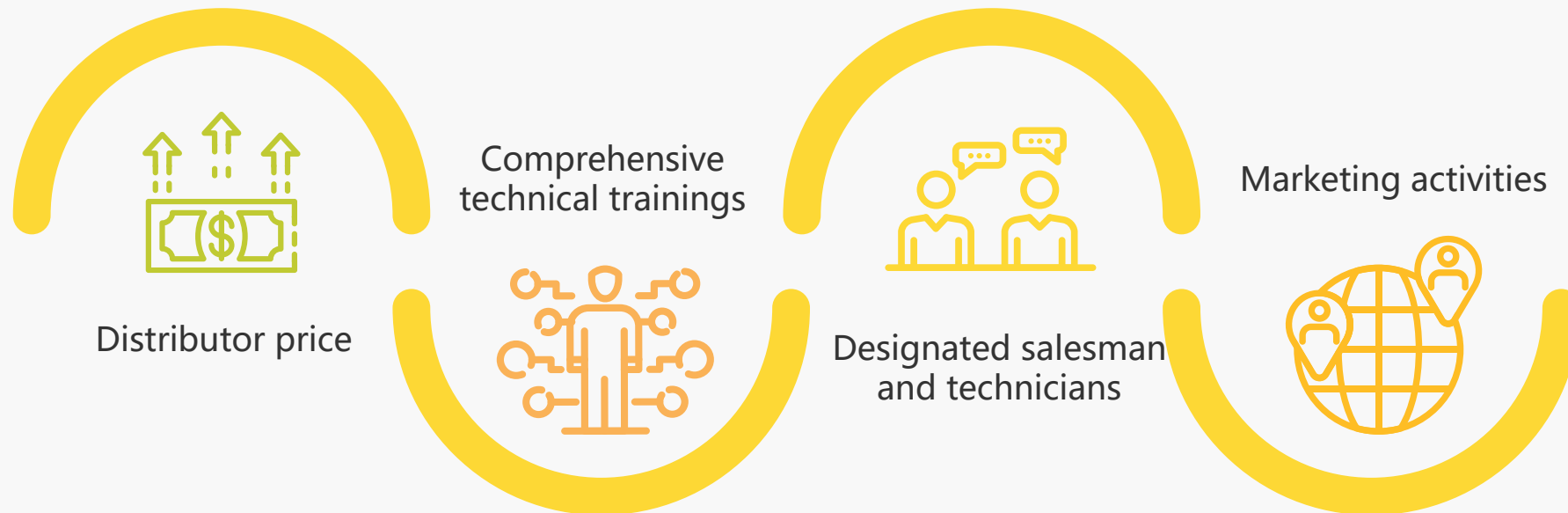

Content.

PuduBot 2

01

Product Overview

02

Key Features

03

Product Values

04

About Pudu

Milestone

2016



Jan.: Shenzhen-based
Founded in 2016

2017



Mar.: Released First Delivery Product – PuduBot
Jul.: Won Red Dot Award – The Best of the Best

2018



Jun.: Series A Financing: Raised \$8 Million
Nov.: Approved as a National High-tech Corporate

2019



Jun.: Global Strategic Cooperation – Haidilao Hotpot
Sep.: Strategic Cooperation – Xiabu Xiabu
Dec.: Released Multi-featured Products – BellaBot & HolaBot

2020



Jan.: Awarded CES Technology Innovation Award
Feb.: Contributed to Hundreds of Hospitals during COVID-19 Outbreak
Jul.: Series B Financing: Raised over \$15 Million by Meituan
Aug.: Series B+ Financing: Raised \$15 Million by Sequoia China Investment Management LLP
Dec.: Launched Disinfection Robot – Puductor 2

2021

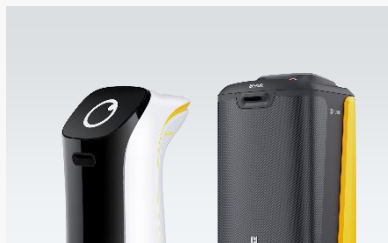

Mar.: Sub-branch R&D Center Set-up
Mar.: Launched New Products - KettyBot & FlashBot
May: Series C1 Financing: Raised \$78 Million by Tencent, Meituan and Sequoia China Investment Management LLP
Sep.: Strategic Cooperation - Panasonic
Sep.: Series C2 Financing: Raised \$77 Million by Meituan, Greater Bay Area Homeland Investments Limited, Shenzhen Investment Holdings Co., Ltd., Sequoia China Investment Management LLP
Oct.: Won G-mark – Good Design Award

2022



May: Released New Delivery Product - SwiftBot
Jun.: Released New Cleaning Product - PUDU CC1

Scale Advantage

Globalization

Pudu Robotics has established a business presence in North America, Europe, East Asia, Asia-Pacific, the Middle East and Latin America. The products have been exported to more than 60 countries around the world, covering more than 600 cities worldwide. Pudu Robotics has established a trustworthy international brand image and become one of the representative enterprises of China's "intelligent" manufacturing abroad.

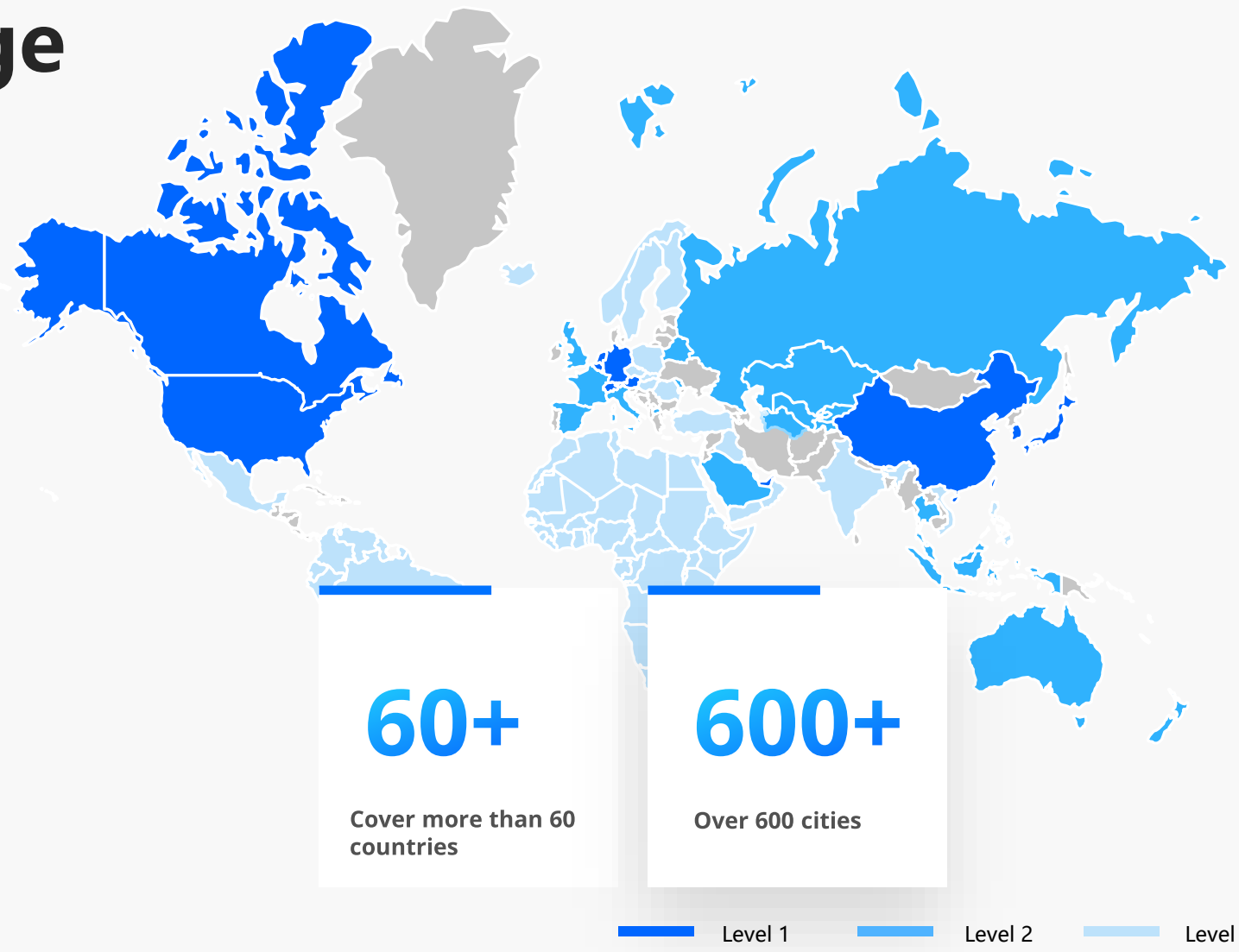

Certificate & Patent

All of existing products have passed the multi-certification that match the targeting markets.



Pudu Robotics has applied for about 1200 core patents, of which invention patents are over 60%, involving positioning, navigation, motion control, human-computer interaction, robotics arm, servo motor, computer vision, cloud platform and other technical fields.



Honor

Pudu Robotics has been recognized by organizations and institutions in various industries.



Cooperation

Pudu Robotics has reached strategic cooperation with many famous brands.



The market share of
Top 100 restaurant clients

24,000+

Deployed Store



Panasonic



DUNKIN'

ZARA



TimHoWan 添好運



MediaMarkt



Coca-Cola



Hilton



全聚德
QUANJUDE
SINCE 1864





Thank you!

 +86 755-86952935

 Global_sales@pudutech.com

 5/F, Building 1A, Shenzhen International Inno Valley Phase 1, Dashi 1st Road, Nanshan District, Shenzhen, China 518300